



Aqua Tech

waterproofing solutions

AquaThene®

Kompleksowy system hydroizolacji opartej na
ELASTYCZNYCH, SAMOPRZYLEPNYCH MEMBRANACH BITUMICZNYCH
wraz z taśmami uzupełniającymi
do izolacji pionowych i poziomych części budowli

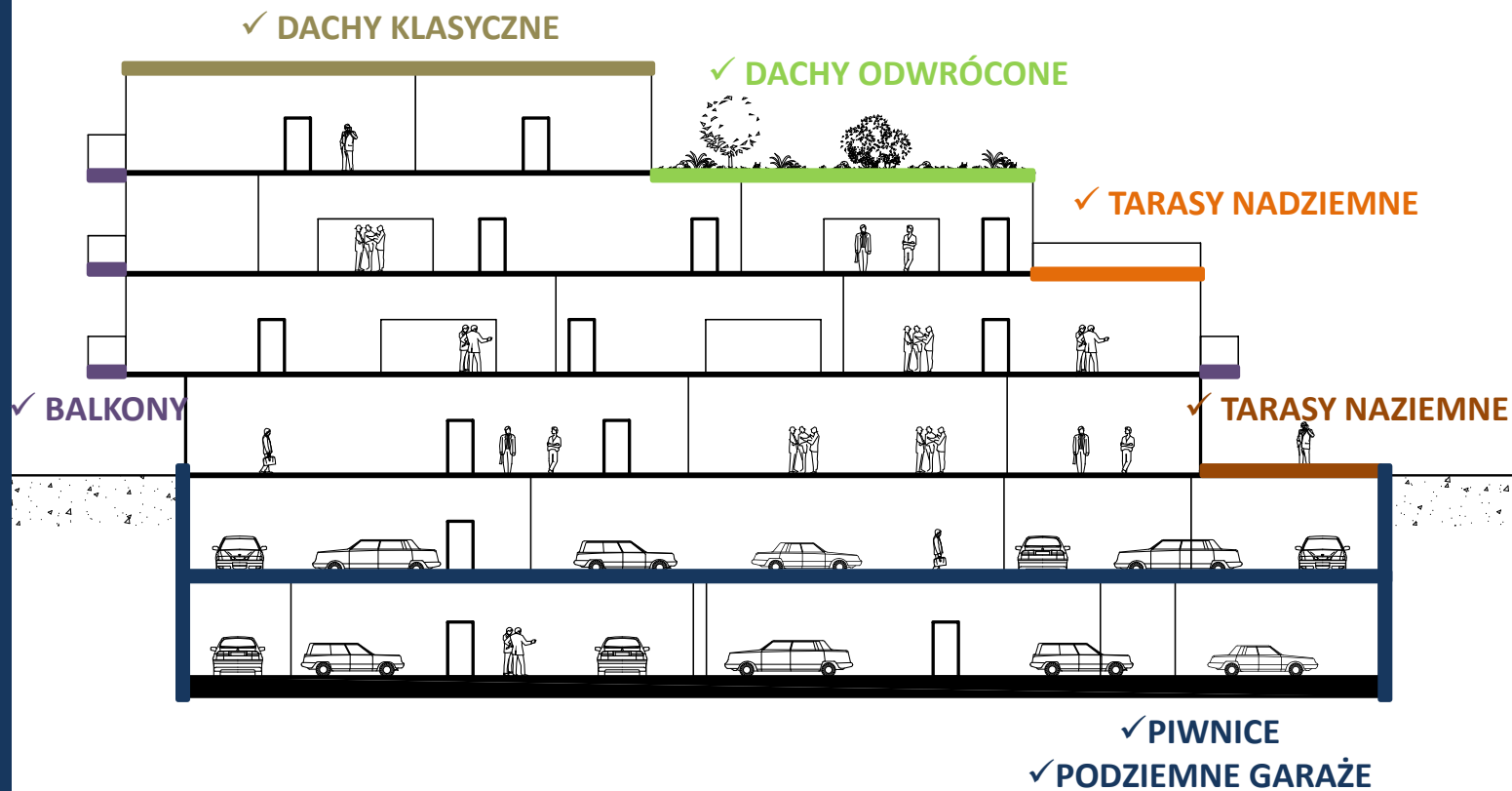

Aqua Tech
waterproofing solutions

WŁAŚCIWOŚCI

Wodoszczelność i gazoszczelność

AquaThene®

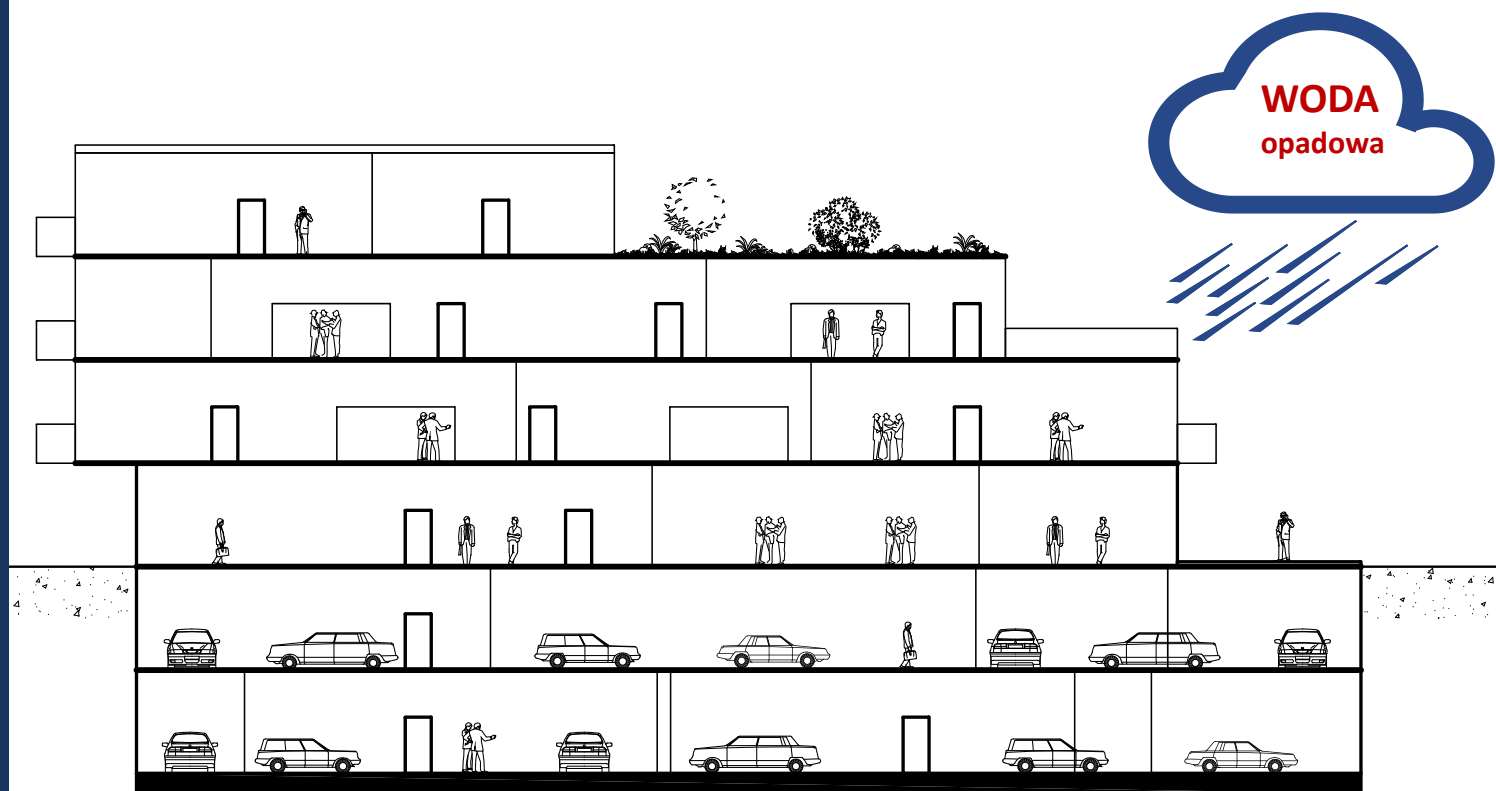

WODOSZCZELNOŚĆ
400 kPa

WODA
AGRESYWNA

Bariera
METAN, RADON



Aqua Tech
waterproofing solutions

WŁAŚCIWOŚCI

AquaThene 4000TS

Izolacja ścian fundamentowych

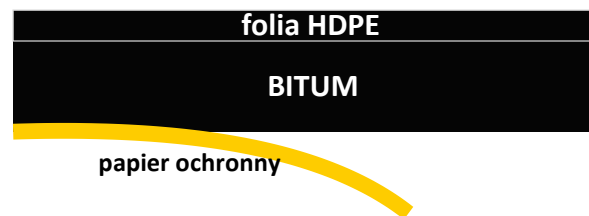

ROZWIĄZANIA TECHNICZNE

piwnice, garaże podziemne

AquaThene®

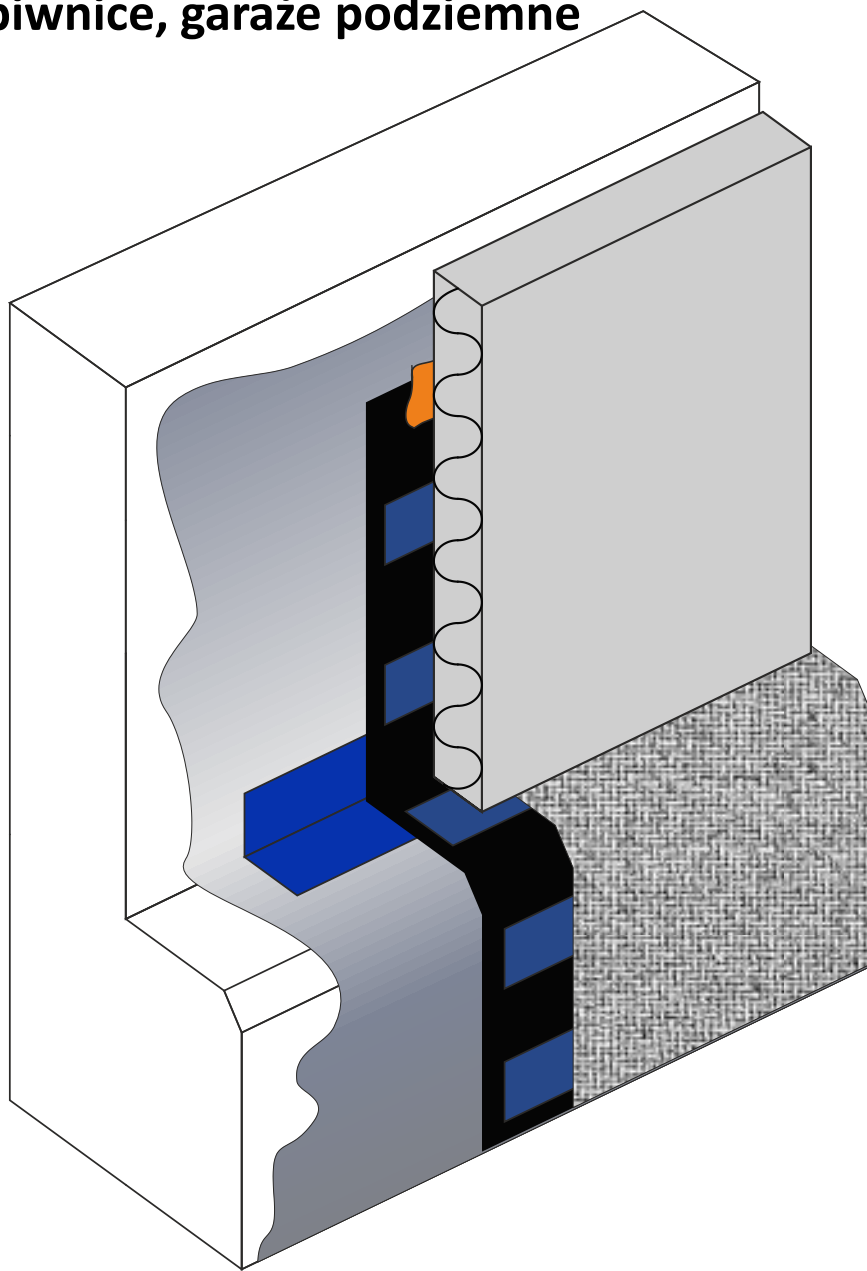

-  AquaThene S/W PRIMER
-  AquaThene CORNER TAPE
-  AquaThene 4000TS
-  AquaThene MASTIC/BAND
-  AquaThene BITAPE
-  Folia kubetkowa
-  Termoizolacja



Aqua Tech
waterproofing solutions

WŁAŚCIWOŚCI

AquaThene 5000T

- ✓ Dach odwrócony
- ✓ Dach zielony w ukł. klasycznym
- ✓ Strop
- ✓ Ściany fundamentowe
- ✓ Płyta fundamentowa na lekkie i średnie warunki wodno-gruntowe

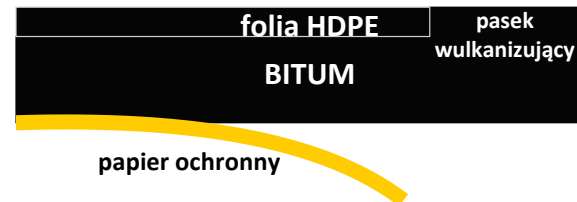

WŁAŚCIWOŚCI

AquaThene ALU

- ✓ Dach płaski w ukł. klasycznym
- ✓ Pod posadzkami
- ✓ Wentylacja

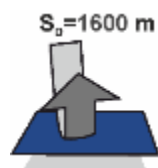

PAROIZOLACYJNOŚĆ

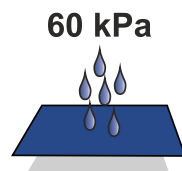

WODOSZCZELNOŚĆ

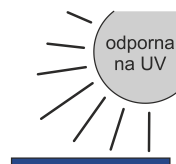

ODPORNĄ NA UV



**OBCIĄŻENIE
STATYCZNE**



Aqua Tech
waterproofing solutions

TAŚMY UZUPEŁNIAJĄCE

AquaThene BITAPE



- ✓ MOCOWANIE WARSTW IZOLACYJNYCH, DRENAŻOWYCH, TAŚM DYLATACYJNYCH
- ✓ USZCZELNIANIE DETALI

AquaThene ALU TAPE



- ✓ KRAWĘDZI MEMBRAN AQUATHENE
- ✓ ODSŁONIĘTEGO POSZYCIA DACHU
- ✓ OBRÓBKI DEKARSKIEJ

AquaThene BAND



- ✓ KRAWĘDZI MEMBRAN AQUATHENE
- ✓ COKOŁÓW
- ✓ WARSTWA FIZELINY STANOWI DOSKONAŁE PODŁOŻE POD MINERALNE WARSTWY WYKOŃCZENIOWE

AquaThene CORNER TAPE

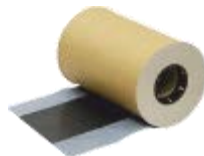

- ✓ NAROŻNIKÓW, NAROŻY I KRAWĘDZI
- ✓ COKOŁÓW
- ✓ STYKU PŁYTY FUNDAMENTOWEJ ZE ŚCIANAMI



WŁAŚCIWOŚCI

mechaniczne

✓ **SILNE** połączenie
membrany z powierzchnią mineralną

AquaThene
S PRIMER



AquaThene
W PRIMER



Aqua Tech
waterproofing solutions



bez gruntowania



z gruntowaniem

MONTAŻ

łatwa aplikacja membrany

AquaThene®

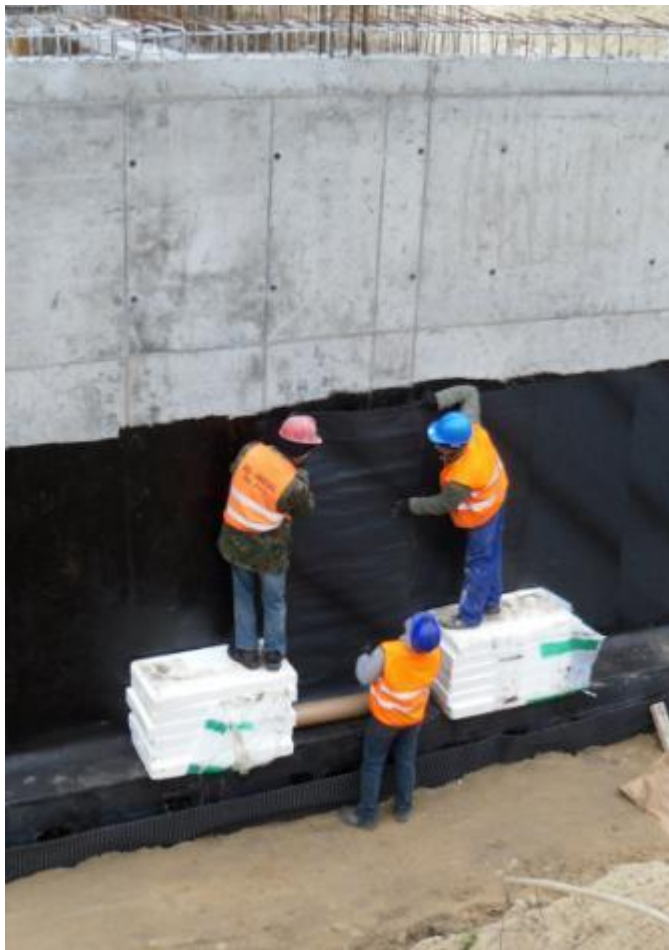

Aqua Tech
waterproofing solutions

AquaThene® to system izolacji przeciwwodnej opartej na **ELASTYCZNYCH, SAMOPRZYLEPNYCH MEMBRANACH BITUMICZNYCH** wraz z taśmami uzupełniającymi do izolacji pionowych i poziomych części budowli i budynków

ZALETY SYSTEMU

- ✓ **prosty montaż**
- ✓ **natychmiastowa wodoszczelność**
- ✓ **skuteczna bariera** przed agresywnym działaniem wód gruntowych
 - ✓ obniża **czas i koszty** budowy
 - ✓ mostkuje rysy
- ✓ **kompletny system**
- ✓ prosta izolacja miejsc przebicia membrany
- ✓ kompatybilny z systemem AquaSlab®



Dziękuję za uwagę

www.aqua-tech.com.pl



Aqua Tech
waterproofing solutions